

ZCRPxxHE

## 19" amp-racks

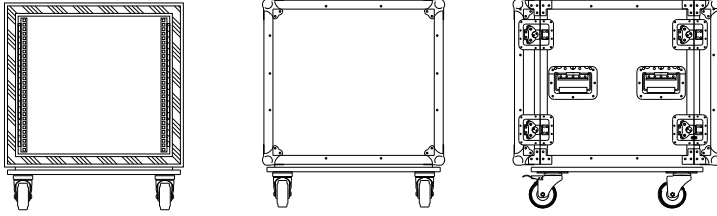

professional version  
„rack in rack“  
with shock absorbing

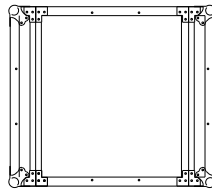

## rack module

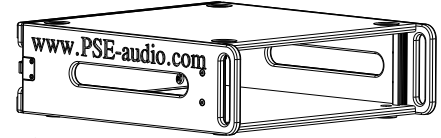

ZCRMxxHE



## case for rack module

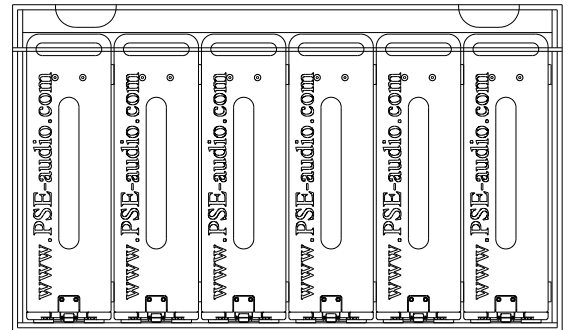

## GS-15 double case

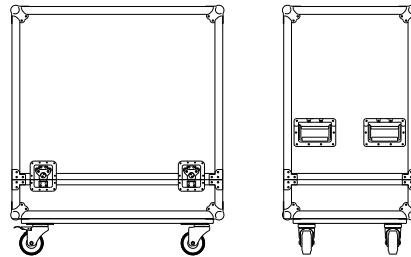
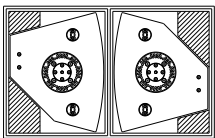

ZCGS1502

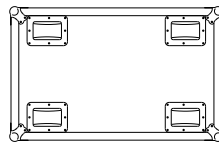
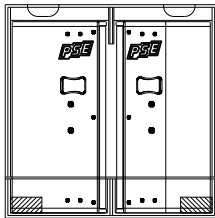

## cases for cable and accessories

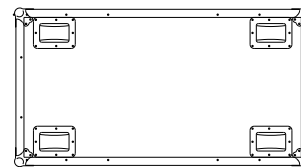

ZCSPZRMxx

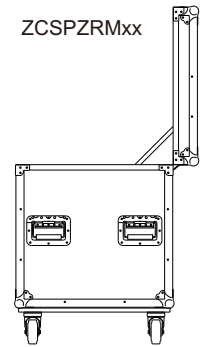
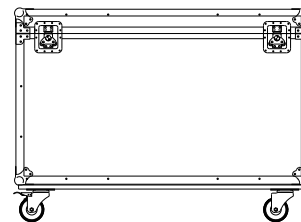

## GS-15 single case

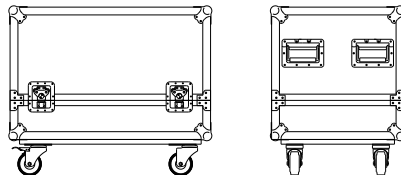
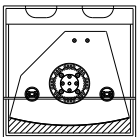

ZCGS1501

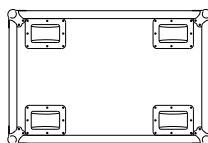
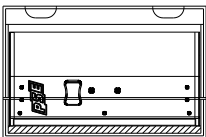

## cases for cable and accessories

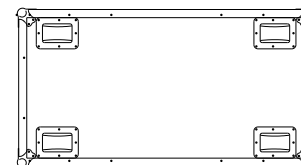

ZCSPZxxx

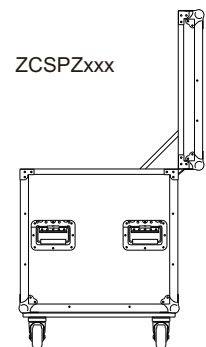
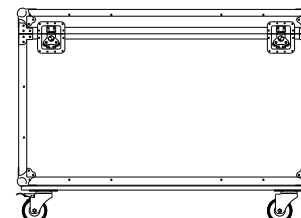

## speaker cables

ZCSPZRMxx



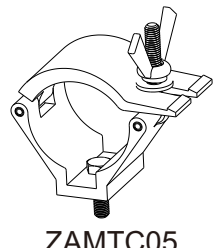
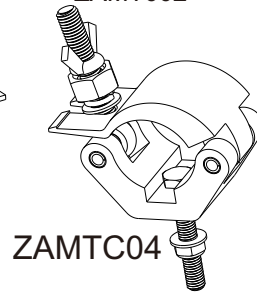
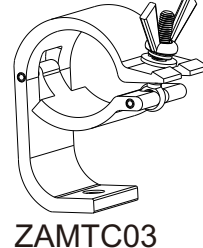
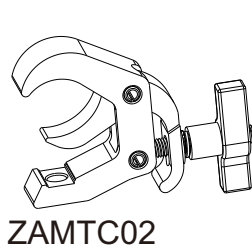
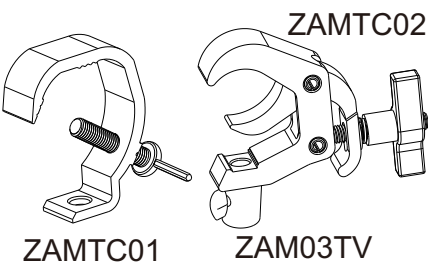
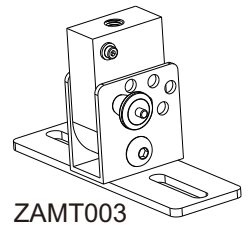
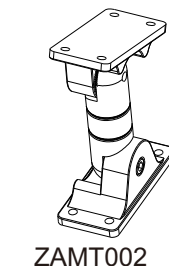
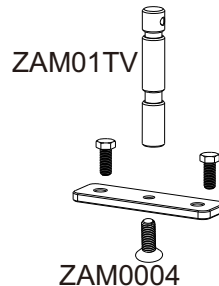
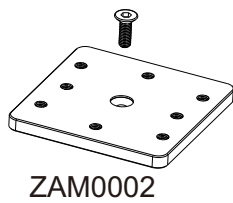
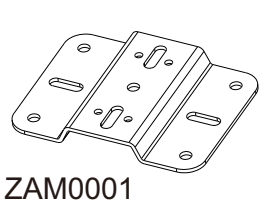
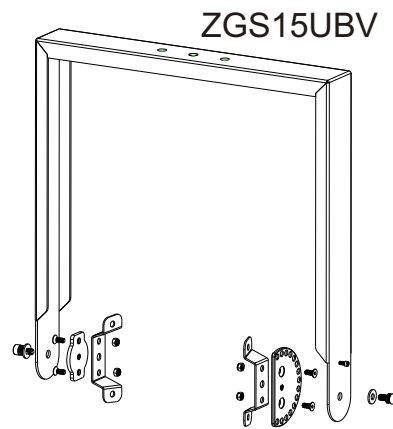
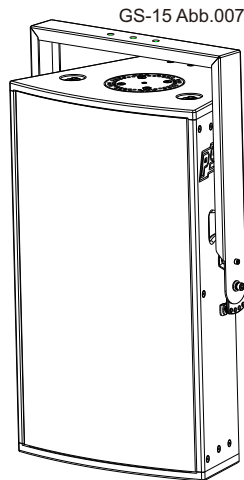
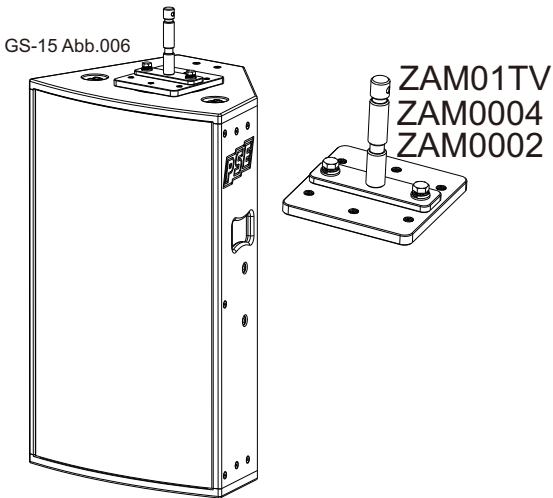
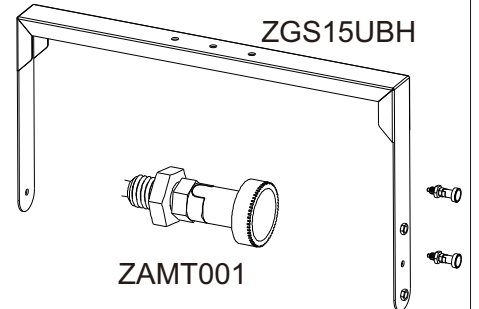
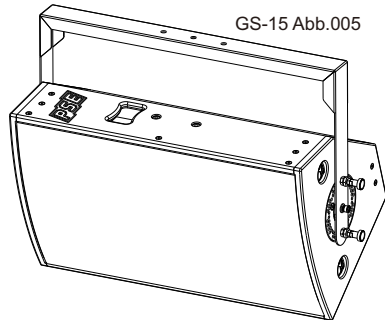
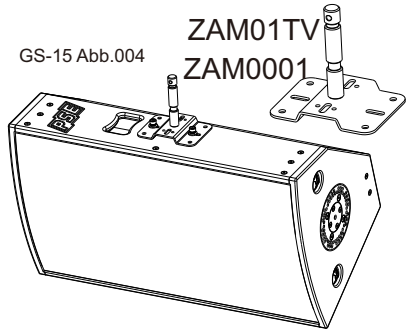
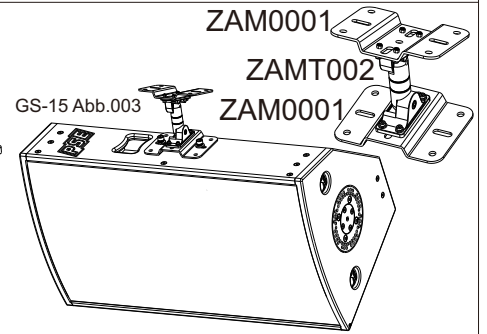
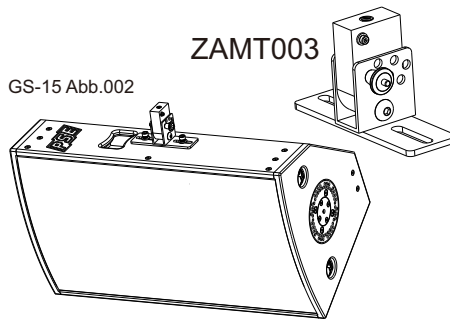
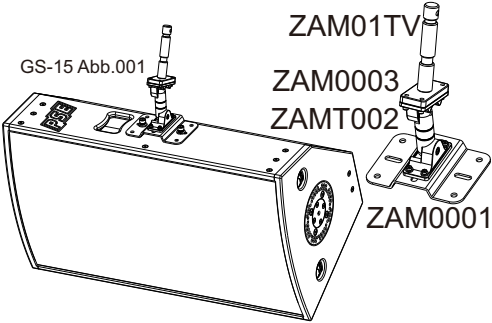

GS-15 Abb.008

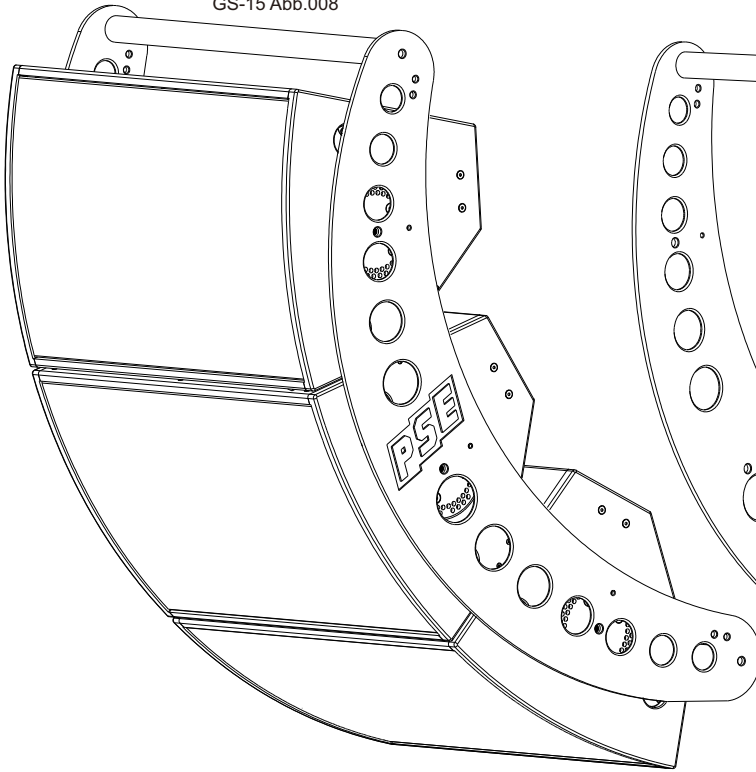

ZAMF001

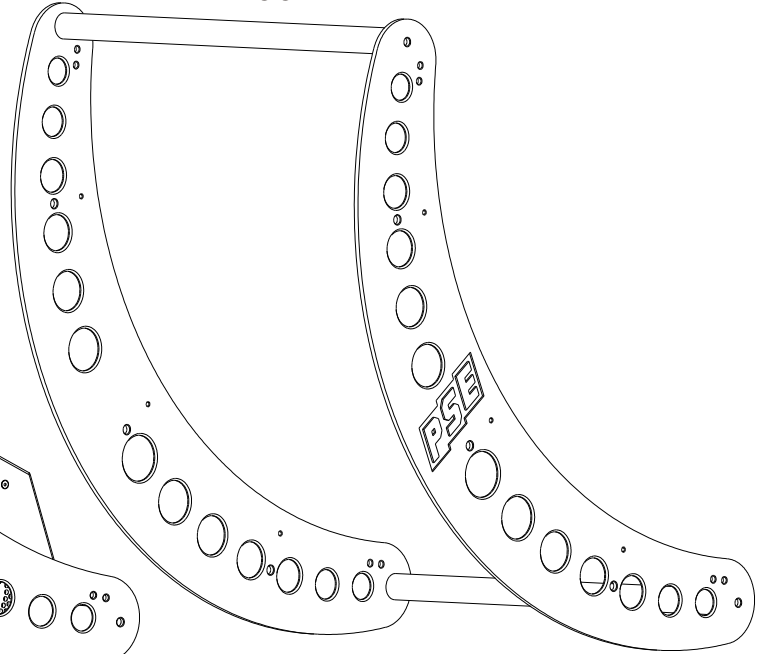

GS-15 Abb.009

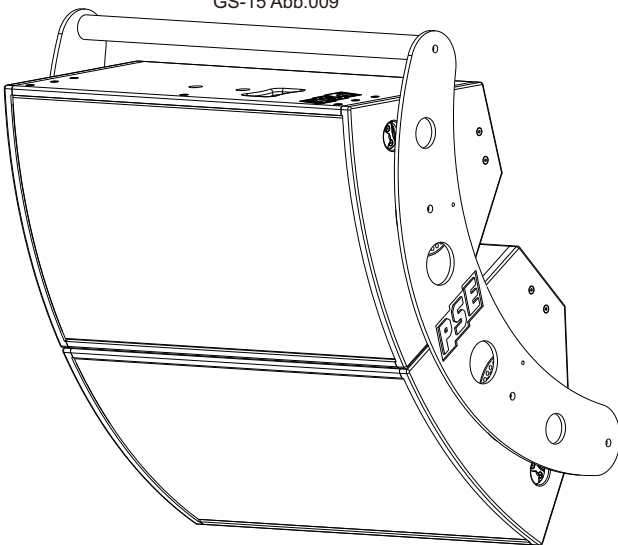

ZAMF002

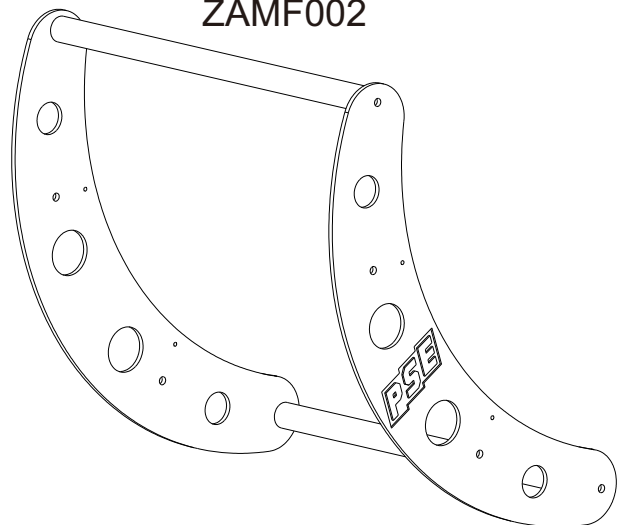

GS-15 Abb.010

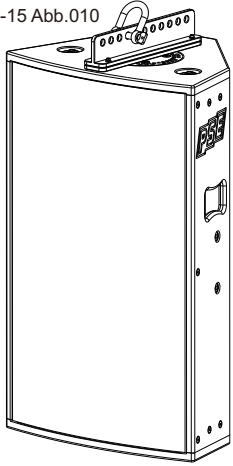

GS-15 Abb.011

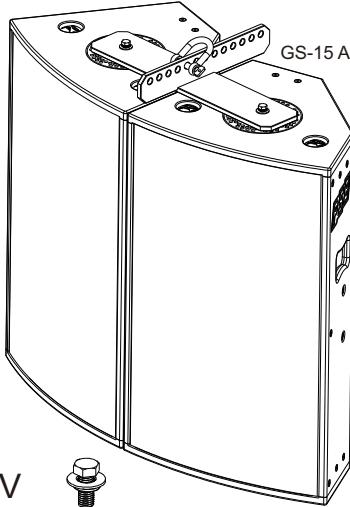

GS-15 Abb.012

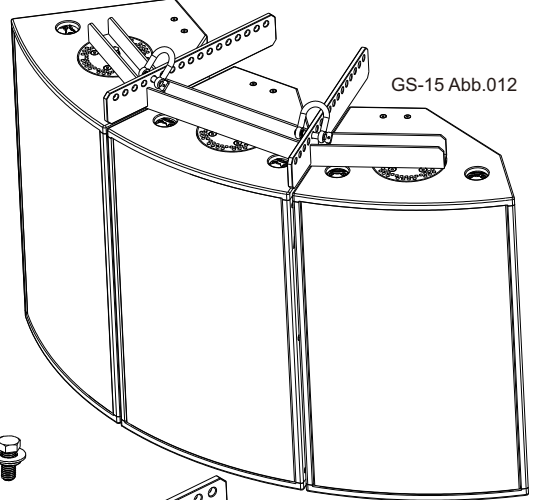

ZAM02TV

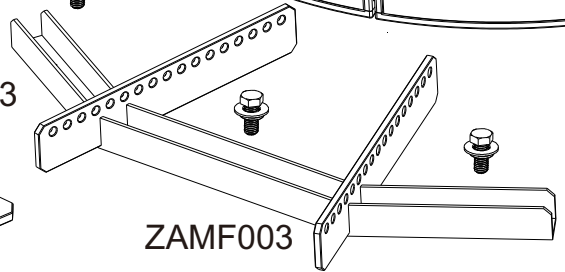
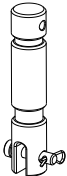

ZAMF003

ZAMF003

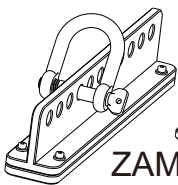

ZAMF005

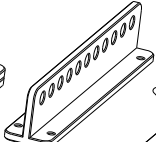

ZAMF006

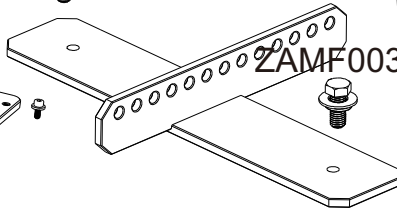
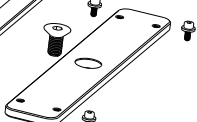

ZAMF007

GS-15 Abb.013

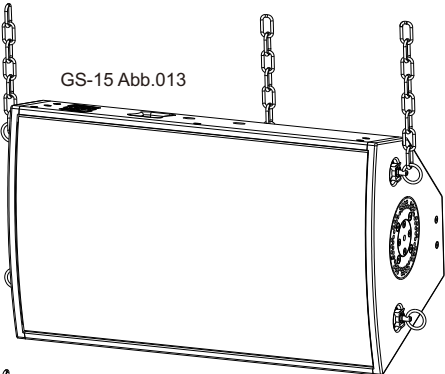

GS-15 Abb.014

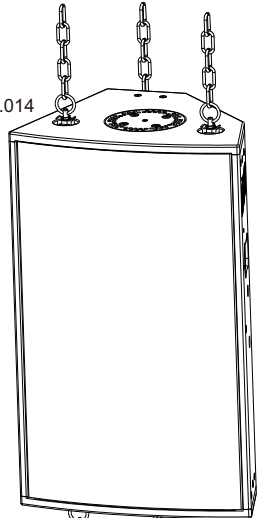

GS-15 Abb.015

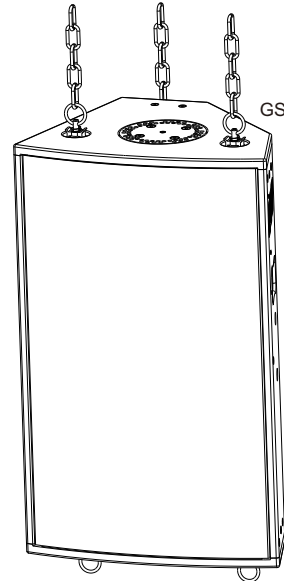

GS-15 Abb.016

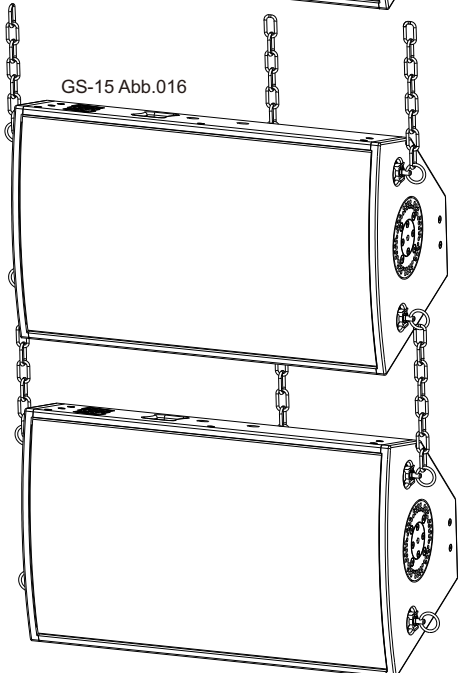

ZAMT004

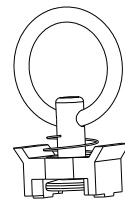

ZAMT006

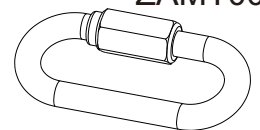

ZAMT005

